

FRONT & SIDE VIEW

MODEL DL1402A
 1400lb/636kg CAPACITY
 PULLING WINCH

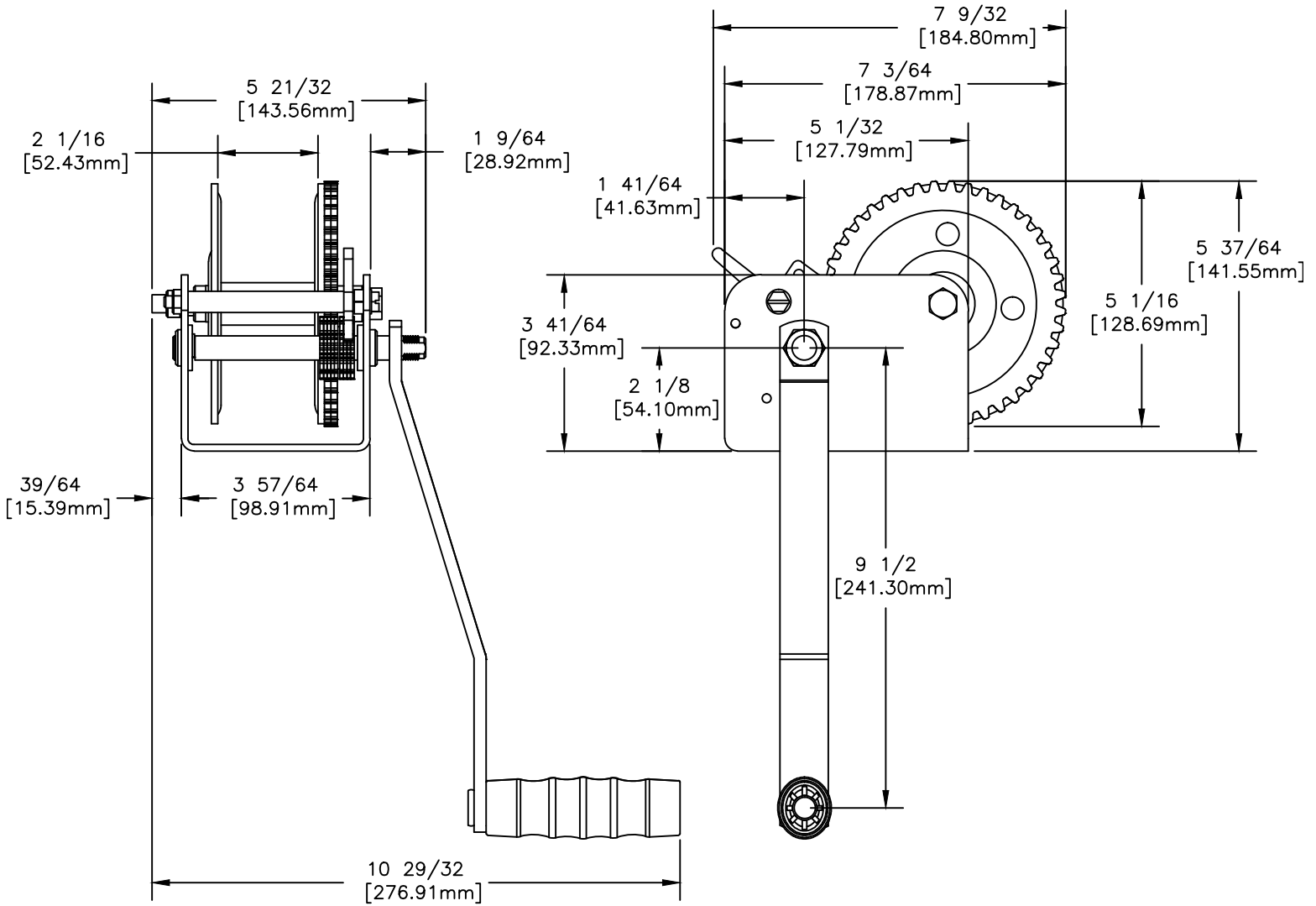

BASE HOLE PATTERN

